

Resources for Improving Comfort and Saving Energy/Money at Home

Richard Reilly, LEED AP, BPI BA & EP





Statistics on coal use

- Coal arrives by train. Each train has 139 cars.
- There are 117 tons of coal per car and 16,300 tons per train.
- At peak load, Labadie burns 23 tons per minute, or 33,000 tons per day.

33,000 tons per day / 16,300 tons per train =

2 trains per day

A 2,000-kWh-per-month house would consume
as much energy in one day as is contained in

70 pounds of coal

One month for the same house:

2,100 pounds of coal

If all our electricity came from

LABADIE

How Energy Is Used in Homes (2005)*

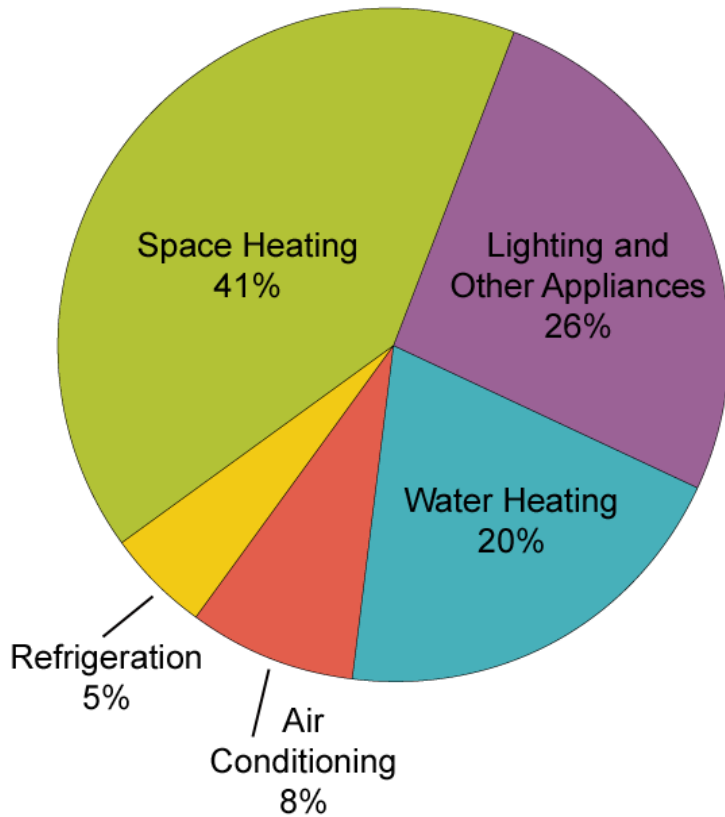

* 2005 is the most recent year for which data are available.

Source: U.S. Energy Information Administration, *Residential Energy Consumption Survey 2005*.

Share of Energy Consumed by Major Sectors of the Economy, 2010

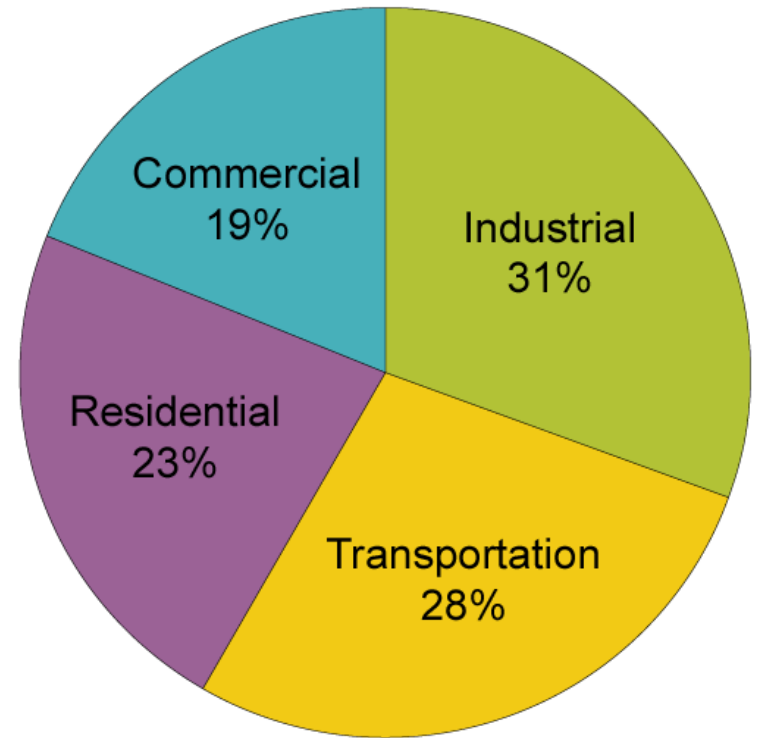

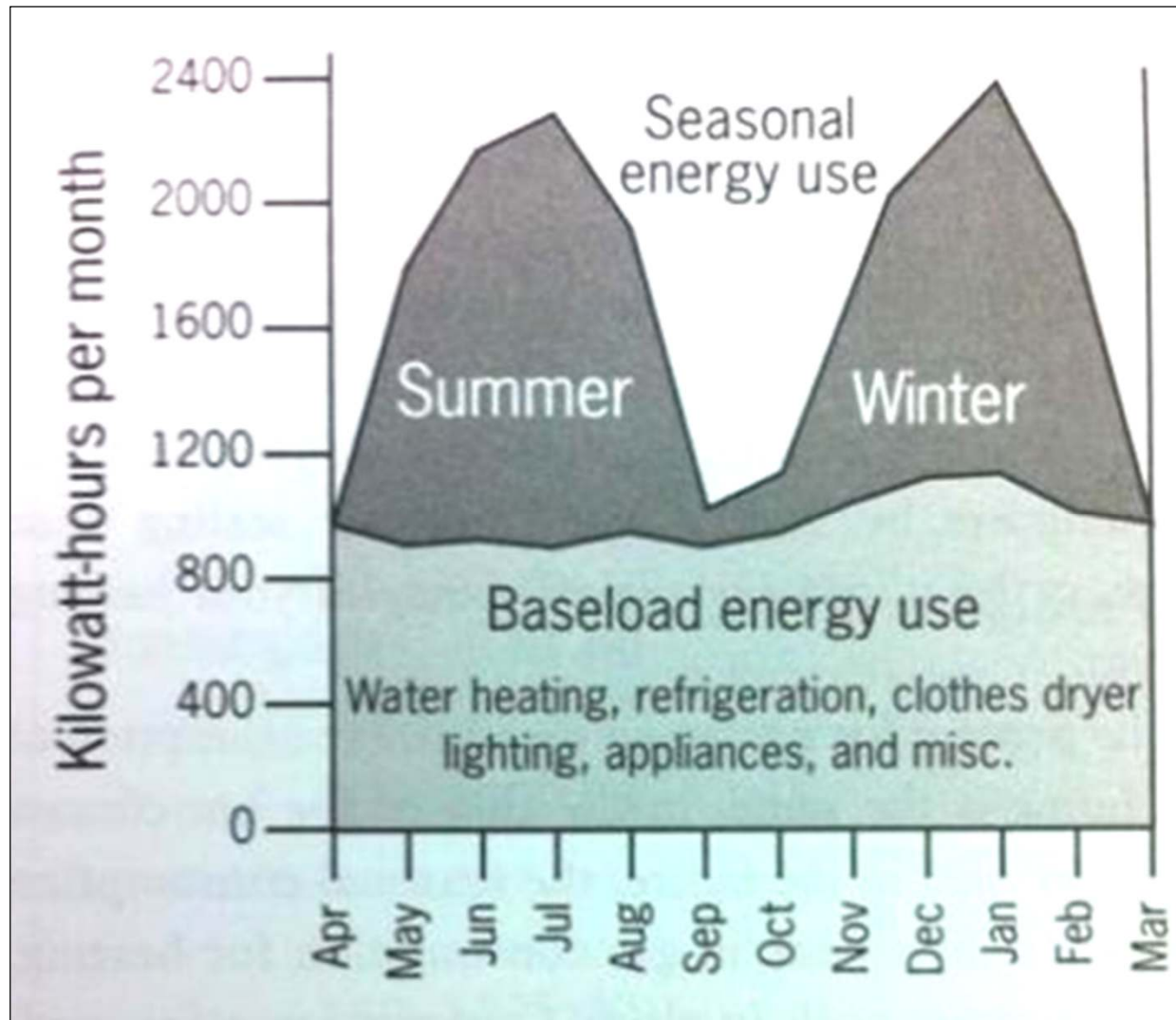

Source: U.S. Energy Information Administration, *Annual Energy Review 2009*, and *Monthly Energy Review (June 2011)*, preliminary 2010 data.



Baseload vs. Seasonal Consumption

COMMON AIR LEAKS

-  Air Leaking into the house
-  Air Leaking out of the house

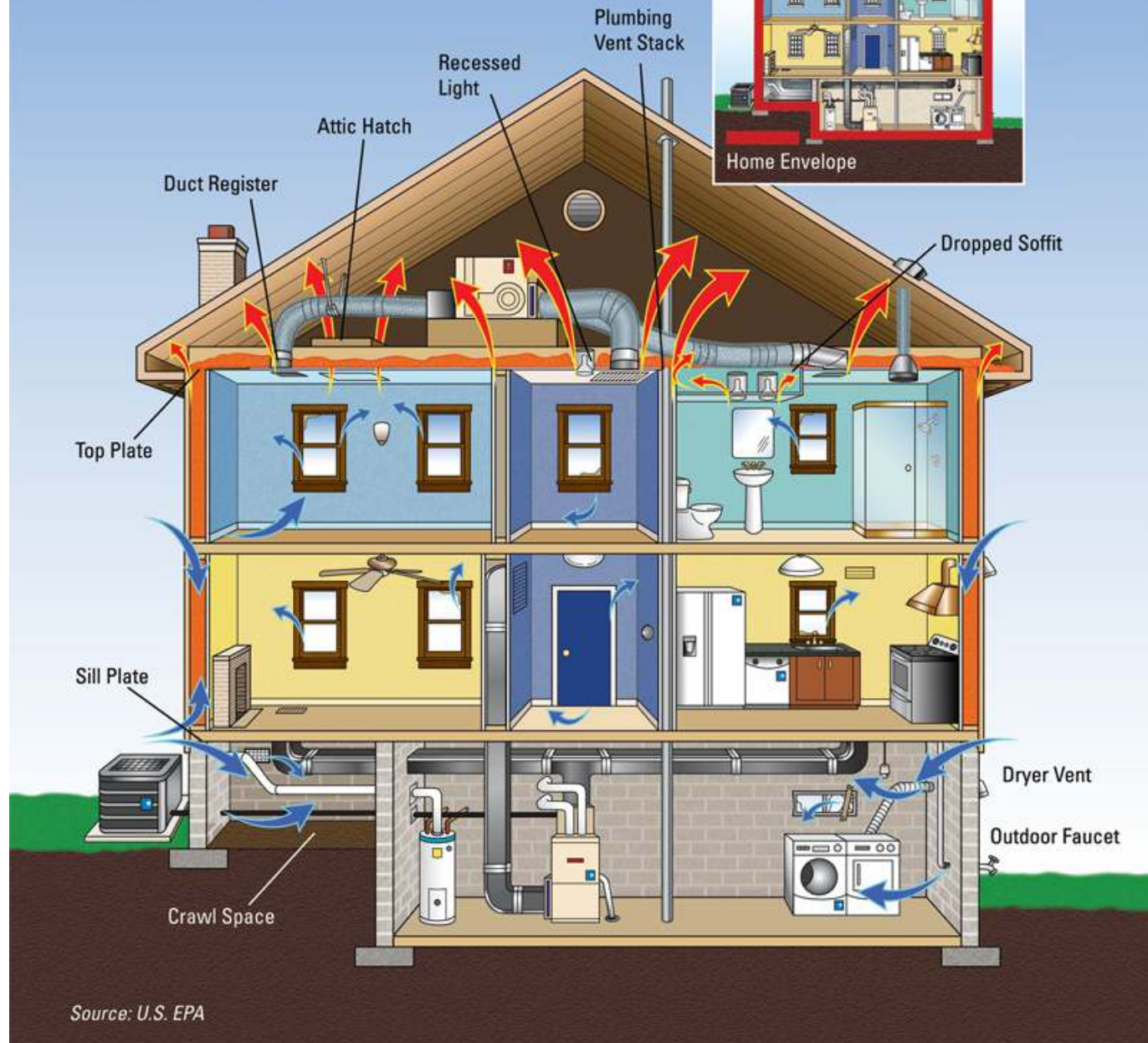

Source: U.S. EPA

Energy Efficiency Basics

- Make a plan
- Embodied energy and durability
- The gamut from weatherization to deep energy retrofits
- Analyzing your energy consumption
 - Vampire electric/ smart strips
 - Mini-meters
- Home Energy Assessment/ Audit
 - Safety 1st
 - CAZ
 - Blower Door
 - HVAC, lighting, appliances, IAQ & more
- You now have a baseline!



Double Hung Windows & Interior Transoms

Cool air in the bottom
and warm air out the top

- Other old school/ DIY strategies
 - Deciduous trees on the south side
 - Using shades/curtains when appropriate



Windows

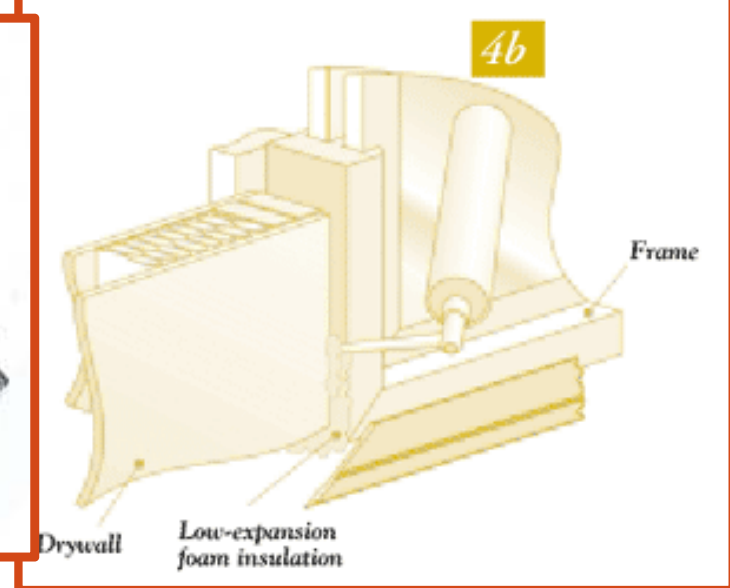
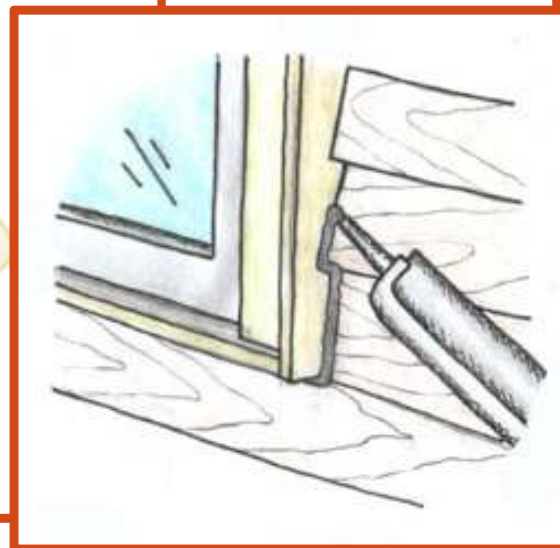
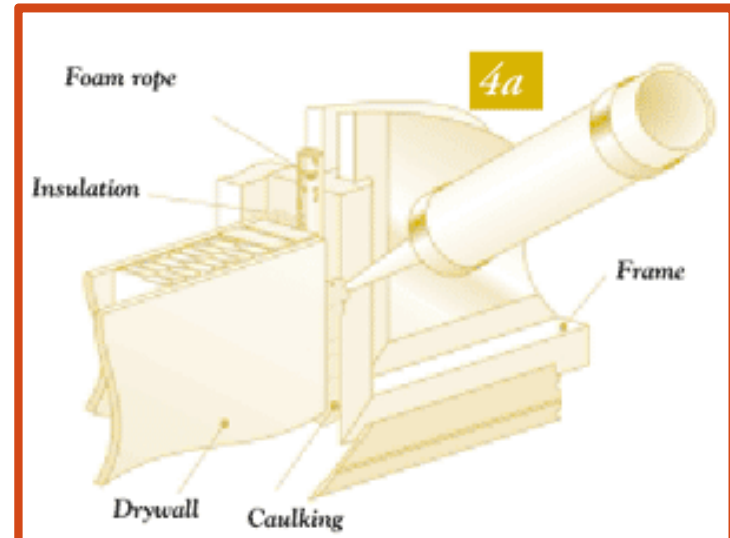
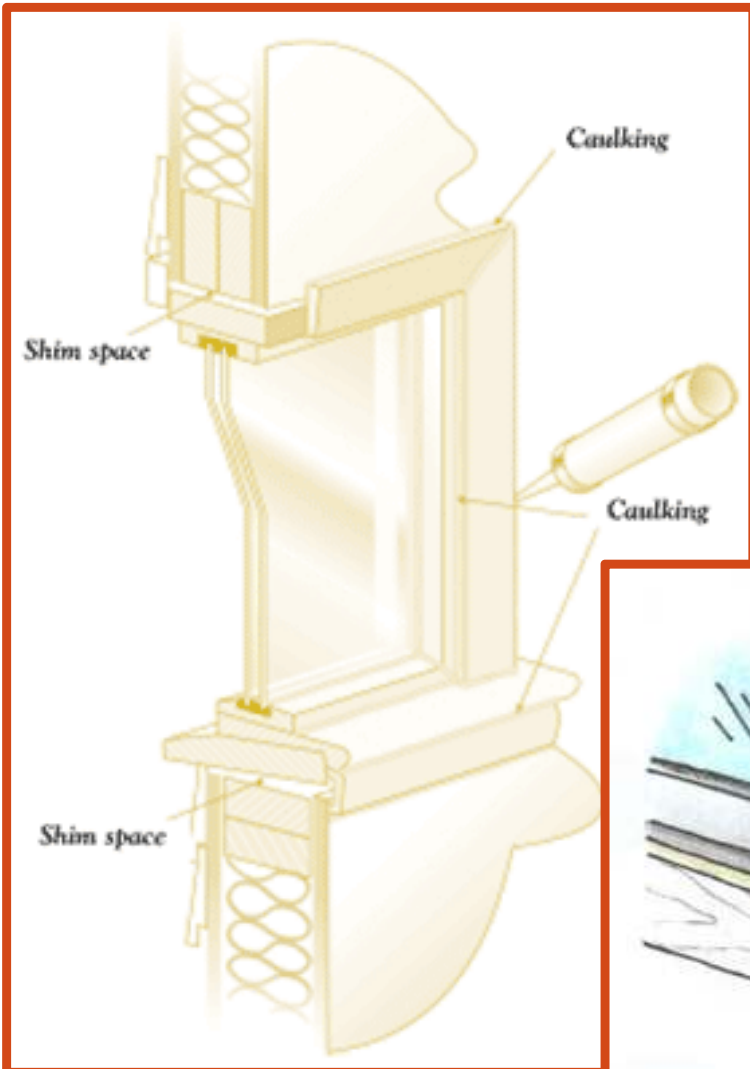

Doors

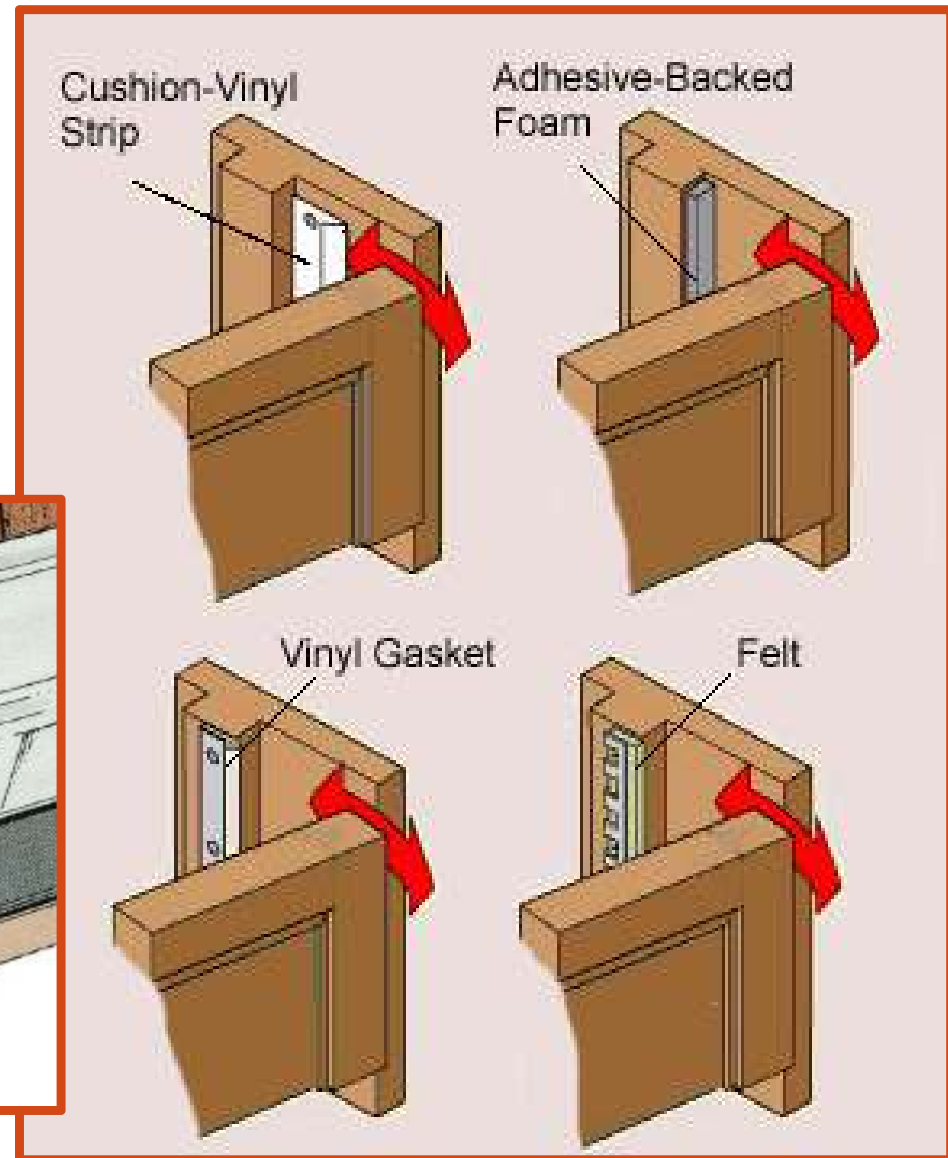
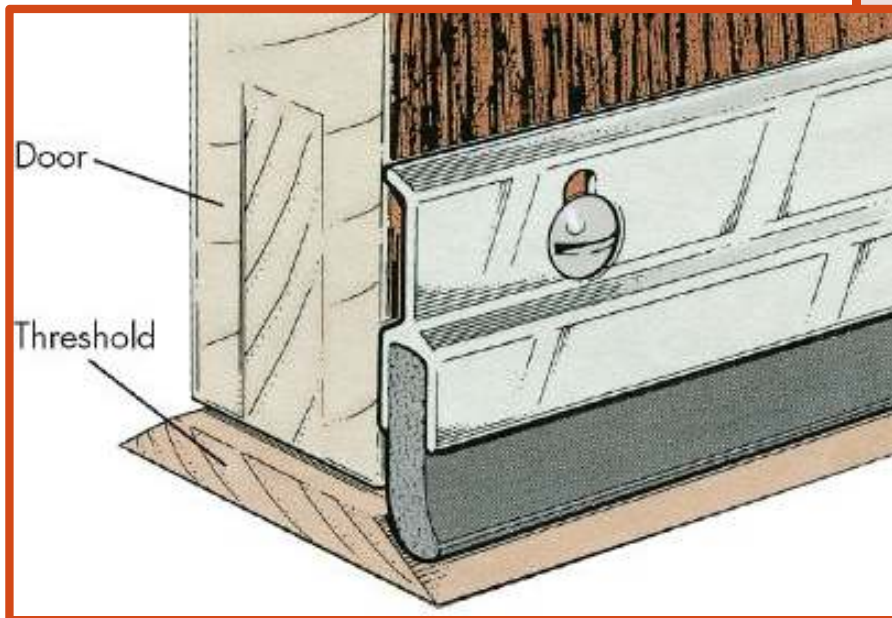

Insulation saves money

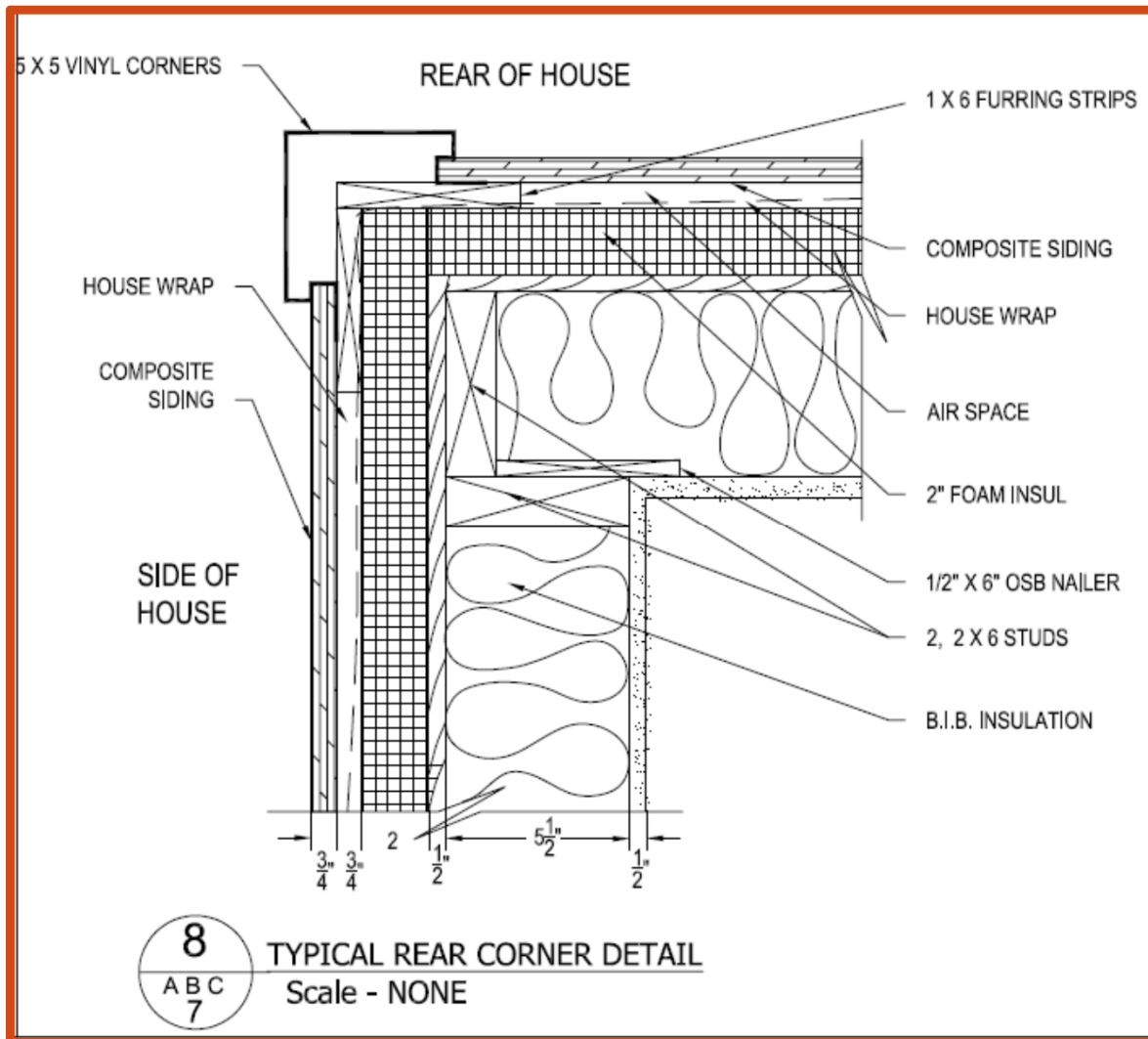

- Sealing
- Ventilation
- Moisture control
- Proper installation
- R-value and an old brick home

Attic Insulation

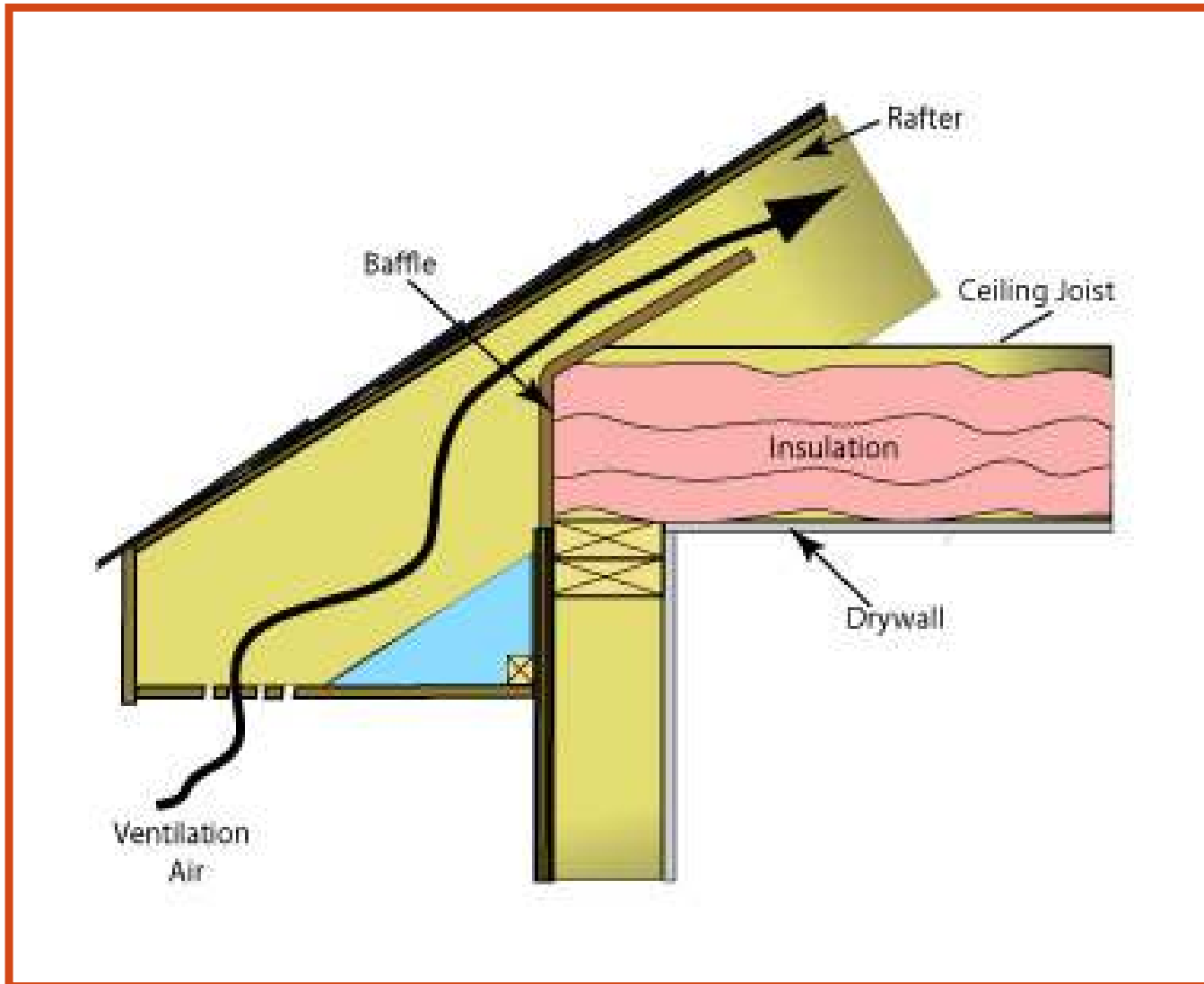

Missouri Botanical Garden

- Web Resources

- www.mobot.org/sustainability
- <http://www.ameren.com/sites/AEA/Pages/Home.aspx>
- <http://www.lacledegas.com/efficiency/>
- www.greenhomeguide.com
- www.greenbuildingadvisor.com

- Real world experience:
 - Air sealing, then insulation
 - Trust but verify
 - In hvac bigger is not better – it's worse
 - Windows typically have the lowest ROI
 - Questions?????



MISSOURI
BOTANICAL
GARDEN